

SE-0605SURGC

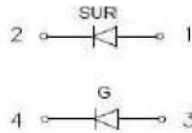
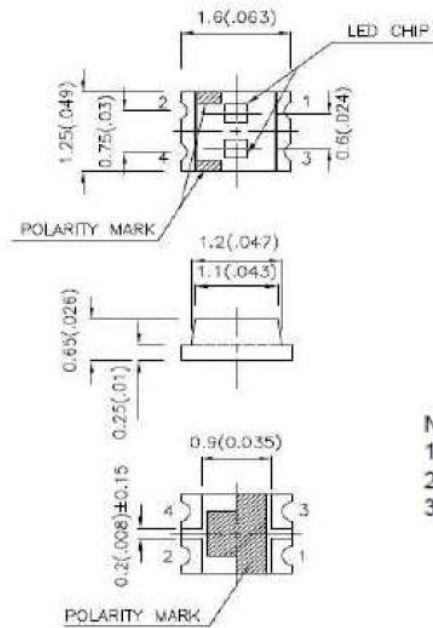

- Notes:
 1. All dimensions are in millimeters (inches).
 2. Tolerance is $\pm 0.2(0.008")$ unless otherwise noted.
 3. Specifications are subject to change without notice.

Dice	Lens Type	Iv (mcd) [2] @ 20mA		Viewing Angle [1]
		Min.	Typ.	2θ1/2
Hyper Red (AlGaInP)	WATER CLEAR	70	220	120°
Green (AlGaInP)		18	50	

- Notes:
 1. θ1/2 is the angle from optical centerline where the luminous intensity is 1/2 of the optical peak value.
 2. Luminous intensity/ luminous Flux: +/-15%.

Absolute Maximum Ratings at TA=25°C

Parameter	Maximum Rating	Unit
DC Forward Current	30	mA
Power Dissipation	R	170
	G	105
		mW
Pulse Current (1/10 Duty Cycle, 0.1ms Pulse Width)	185	mA
Reverse Voltage(V _r)	5	V
Operating Temperature Range	-40°C to + 85°C	
Storage Temperature Range	-40°C to + 85°C	
Lead Soldering Temperature	230°C for 5 Seconds	

Electrical / Optical Characteristics at TA=25°C

Parameter	Symbol	Min.	Typ.	Max.	Unit	Test Condition
Luminous Intensity	IV(R)	70	150		mcd	IF = 20mA
	IV(G)	18	50			
Viewing Angle	2θ1/2		120		deg	IF = 20mA
Dominant Wavelength	λd(R)		635		nm	IF = 20mA
	λd(G)		570			
Forward Voltage	VF(R)		1.95	2.5	V	IF = 20mA
	VF(G)		2.1	2.5		
Reverse Current, any Dot	IR			10	μA	VR = 5V

SE-0605SURGC

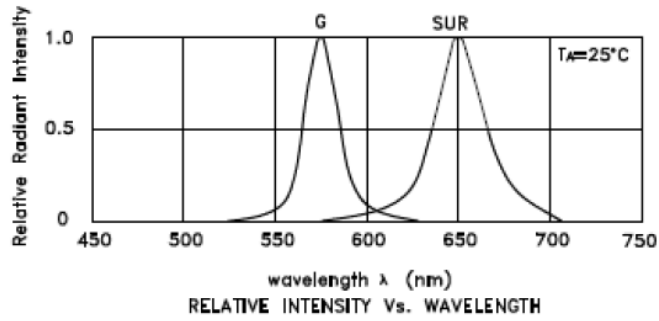

Red

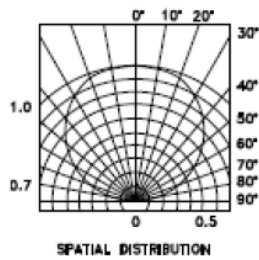
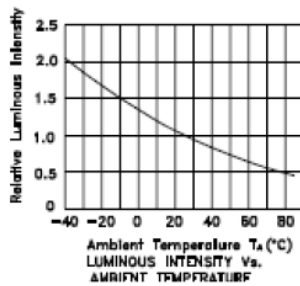
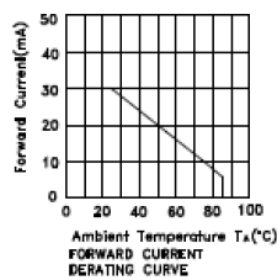
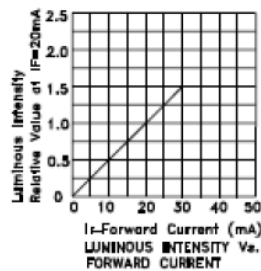
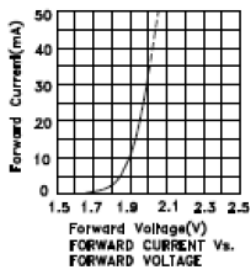

Green

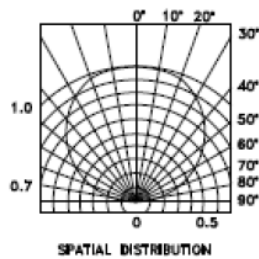
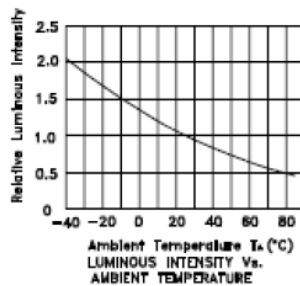
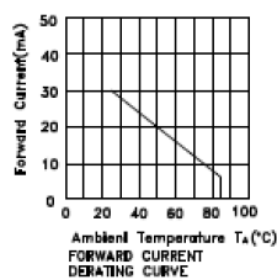
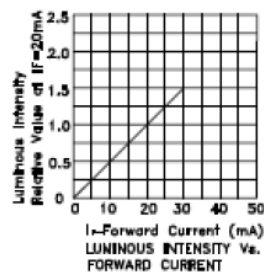
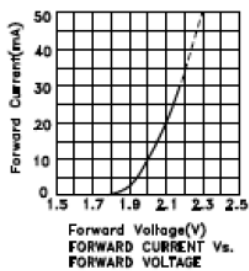

SE-0605SURGC

Reflow soldering is recommended and the soldering profile is shown below.
Other soldering methods are not recommended as they might cause damage to the product.

Reflow Soldering Profile For Lead-free SMT Process.

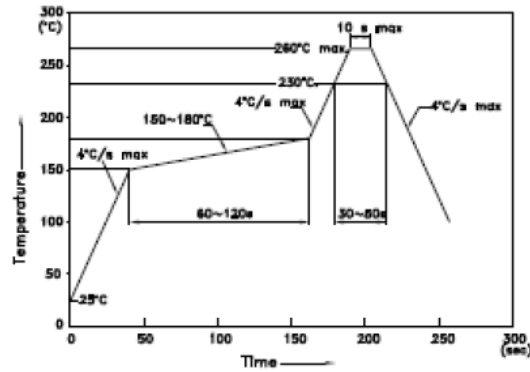

- NOTES:
1. We recommend the reflow temperature 245°C(+/-5°C). The maximum soldering temperature should be limited to 260°C.
 2. Don't cause stress to the epoxy resin while it is exposed to high temperature.
 3. Number of reflow process shall be 2 times or less.

Recommended Soldering Pattern
(Units : mm; Tolerance: ± 0.1)

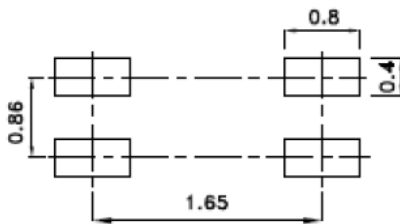

Reel Dimension

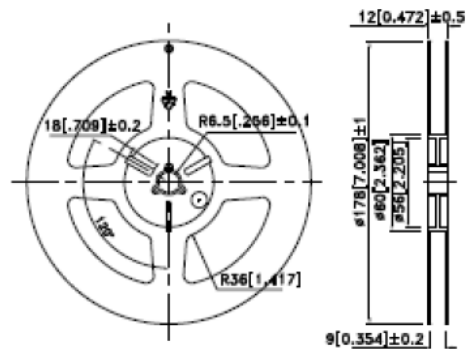

Tape Dimensions
(Units : mm)

