

BS Elektronik Service GmbH

Webseite: www.bs-elektronik-service.de E-Mail: info@bs-elektronik-service.de

Katalog für Flexible LED- Rollen u. Zubehör

1, High quality led

2, All Strips has same color temperature. Warm white(2800-3300K), Cool white(6000-6500K).

3, All relevant component available



1), 1m Strip Kit : 1pcs 1m strip + 1pcs power connect wire + 2pcs middle connector.

2), 5m strip kit: 5m strip + driver + controller/dimmer.

3), Neutral packing, MOQ 10 reels.

4), Can add customer's logo on the package.





BS Elektronik Service GmbH

Webseite: www.bs-elektronik-service.de E-Mail: info@bs-elektronik-service.de

Group 1: Non-waterproof 3528 Strip

Non-waterproof type

Item No	Description	LED	Length	PCB width	Voltage	Wattage	Package	Color	Productphoto
5m SMD3528 flexible light strip, 60 leds/meter, 12V/2A									
SE-3528WW-flex-12V	non-waterproof 5m vertical strip	300pcs smd3528	5m per reel	8mm	12V	24W	1, 5m / reel. 2, 3M double-size tape on back of strip. 3, Ziplock bag. 4, drying agent	Warm white	
SE-3528CW-flex-12V								Cool white	
SE-3528G-flex-12V								Green	
SE-3528B-flex-12V								Blue	
SE-3528R-flex-12V								Red	
SE-3528Y-flex-12V								Yellow	
5m SMD3528 flexible light strip, 120 leds/meter, 12V/4A									
SE-3528WW600-flex-12V	non-waterproof 5m vertical strips	600pcs smd3528	5m per reel	10m m	12V	48W	1, 5m / reel. 2, 3M double-size tape on back of strip. 3, Ziplock bag. 4, drying agent	Warm white	
SE-3528CW600-flex-12V								Cool white	
SE-3528G600-flex-12V								Green	
SE-3528B600-flex-12V								Blue	
SE-3528R600-flex-12V								Red	
SE-3528Y600-flex-12V								Yellow	



BS Elektronik Service GmbH

Webseite: www.bs-elektronik-service.de E-Mail: info@bs-elektronik-service.de

Group 2: Non-waterproof 5050/5060 Strip

Non-waterproof type

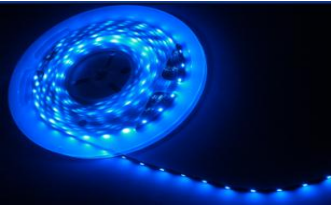
- 1, Low light degradation: up to 75% lumen maintenance after 35,000hrs operating.
- 2, Good color consistency: Tiny difference between two orders.



Item No	Description	LED	Length	PCB width	Voltage	Wattage	Package	Color	Productphoto
5m SMD5060 flexible light strip, 30 leds/meter, 12V/3A									
SE-5060RGB-flex-12V	non-waterproof 5m vertical strip	150pcs smd5060	5m per reel	10m m	12V	36W	1, 5m / reel. 2, 3M double-size tape on back of strip. 3, Ziplock bag. 4, drying agent	RGB	
SE-5060WW-flex-12V								warm white	
SE-5060CW-flex-12V								cool white	
SE-5060G-flex-12V								Green	
SE-5060B-flex-12V								Blue	
SE-5060R-flex-12V								Red	
SE-5060Y-flex-12V								Yellow	
5m SMD5060 flexible light strip, 60 leds/meter, 12V/6A									
SE-5060RGB300-flex-12V	non-waterproof 5m vertical strip	300pcs smd5060	5m per reel	10m m	12V	72W	1, 5m / reel. 2, 3M double-size tape on back of strip. 3, Ziplock bag. 4, drying agent	RGB	
SE-5060WW300-flex-12V								warm white	
SE-5060CW300-flex-12V								cool white	
SE-5060G300-flex-12V								Green	
SE-5060B300-flex-12V								Blue	
SE-5060R300-flex-12V								Red	
SE-5060Y300-flex-12V								Yellow	

BS Elektronik Service GmbH

Webseite: www.bs-elektronik-service.de E-Mail: info@bs-elektronik-service.de

Group3: Color Temperature adjustable led strip

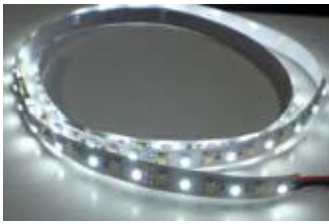
Advantage: With our special controller, you can adjust temperature and brightness of the strip freely





Item No	LED	Length	PCB width	Voltage	Wattage	Package	Product photo
Color temperature adjustable led strip, 5m SMD 3528 flexible light strip, 60 leds/meter, 12V/2A							
SE-3528W-WW300-12V	150pcs warm white smd 3528 & 150 pcs cool white smd 3528	5m per reel	10mm	12V	24W	1, 5m / reel 2, 3M double size tape on back to strip 3, Ziplock bag. 4, drying agent	
Color temperature adjustable led strip, 5m SMD 3528 flexible light strip, 120 leds/meter, 12V/4A							
SE-3528W-WW600-12V	300 pcs warm white smd 3528 & 300 pcs cool white smd 3528	5m per reel	10mm	12V	48W	1, 5m / reel 2, 3M double size tape on back to strip 3, Ziplock bag. 4, drying agent	
Color temperature adjustable led strip, 5m SMD 5050 flexible light strip, 60 leds/meter, 12V/6A							
SE-5050W-WW300-12V	300 pcs warm white smd 5050 & 300 pcs cool white smd 5050	5m per reel	10mm	12V	72W	1, 5m / reel 2, 3M double size tape on back to strip 3, Ziplock bag. 4, drying agent	
Color temperature Controller, 12, 6A per loop							
Farb Temperatur Controller	Color temperatur adjustable controller, 12V, 6A per loop						

BS Elektronik Service GmbH

Webseite: www.bs-elektronik-service.de E-Mail: info@bs-elektronik-service.de

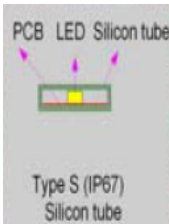
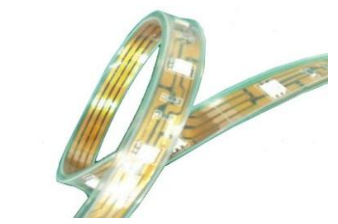
Group 3: 3-choice of waterproof type for smd led strip

waterproof type: We provide 3 types, pls select the one you need.

Item No	Waterproof technology	Advantage	IP rate	Selling Rate	Product photo
IP66	Waterproof type A: Full silicone tube encapsulation . 	Easy to be cut, good price	IP66	5%	
IP65	Waterproof type B: Epoxy resin 	Very thin; Light intensity is good.	IP65	60%	
IP68	Waterproof Type D: Full silicone tube and full epoxy resin 	Fully waterproof, light intensity is good Latest technology!	IP68	35%	

BS Elektronik Service GmbH

Webseite: www.bs-elektronik-service.de E-Mail: info@bs-elektronik-service.de

Quotation of 1m strip Kit (IP65)

Advantage:

- 1, 1m strip with necessary middle connector and power connector
- 2, 2pcs strip can be connected easily, need no extra tools.
- 3, End users can use to meet any length according to their needs.



Item No	Content	Color	Blister Package	Normal Package
SE-3528x30-IP65	1), 1m 3528 strip, 6 led/m, 12V, IP65 Epoxy resin waterproof 2), 2pcs middle connector (strip to strip) 3), 1pcs 20cm end connect wire with DC connector (drive to strip)	WW/W	AUF ANFRAGE	
		R/G/B/Y		
SE-5060x15-IP65	1), 1m 5050 strip, 30 led/m, 12V, IP65 Epoxy resin waterproof 2), 2pcs middle connector (strip to strip) 3), 1pcs 20cm end connect wire with DC connector (drive to strip) or controller-to-strip for RGB Strip	R/G/B/	AUF ANFRAGE	
		WW/W		
		R/G/B/Y		
SE-5060x30-IP65	1), 1m 5050 strip, 60 led/m, 12V, IP65 Epoxy resin waterproof 2), 2pcs middle connector (strip to strip) 3), 1pcs 20cm end connect wire with DC connector (drive to strip) or controller-to-strip for RGB Strip	R/G/B/	AUF ANFRAGE	
		WW/W		
		R/G/B/Y		

BS Elektronik Service GmbH

Webseite: www.bs-elektronik-service.de E-Mail: info@bs-elektronik-service.de

Quotation of 1m strip Kit (IP20)

Advantage:

- 1, 1m strip with necessary middle connector and power connector
- 2, 2pcs strip can be connected easily, need no extra tools.
- 3, End users can use to meet any length according to their needs.

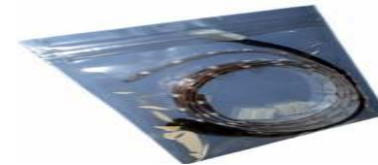
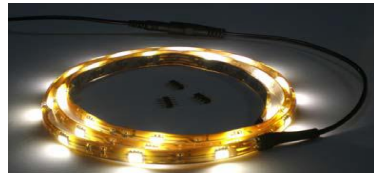

Item No	Content	Color	Blister Package	Normal Package Price
SE-3528x30-IP20	1), 1m 3528 strip, 60 led/m, 12V, non-waterproof 2), 2pcs middle connector (strip to strip) 3), 1pcs 20cm end connect wire with DC connector (drive to strip)	WW/W	AUF ANFRAGE	
		R/G/B/Y		
SE-5060x15-IP20	1), 1m 5050 strip, 30 led/m, 12V, non waterproof 2), 2pcs middle connector (strip to strip) 3), 1pcs 20cm end connect wire with DC connector (drive to strip) or controller-to-strip for RGB Strip	R/G/B/	AUF ANFRAGE	
		WW/W		
		R/G/B/Y		
SE-5060x30-IP20	1), 1m 5050 strip, 60 led/m, 12V, non waterproof 2), 2pcs middle connector (strip to strip) 3), 1pcs 20cm end connect wire with DC connector (drive to strip) or controller-to-strip for RGB Strip	R/G/B/	AUF ANFRAGE	
		WW/W		
		R/G/B/Y		

BS Elektronik Service GmbH

Webseite: www.bs-elektronik-service.de E-Mail: info@bs-elektronik-service.de

Quotation of LED Set Solution (Dimmer)

Feature:

- 1, All below price include both product and blister package.
- 2, LED Stripe type and length can be adjusted as real needs



Item No	Description	Color Temperatur
Non Waterproof, IP 20 series		
Dimmer Set A, IP20	5m IP20 3528 strip (4,8W/m) + Inline dimmer + 12V 24W adaptor	WW (2800-3300K) W (6000-6500K) Green Blue Red Yellow
Dimmer Set B, IP20	2,5m IP20 3528 strip (9,6W/m) + Inline dimmer + 12V 24W adaptor	
Dimmer Set C, IP20	5m IP20 5050 strip (7,2W/m) + Inline dimmer + 12V 36W adaptor	
Dimmer Set D, IP20	2,5m IP20 5050 strip (14,4W/m) + Inline dimmer + 12V 36W adaptor	
waterproof, IP65 series		
Dimmer Set A, IP65	5m IP65 3528 strip (4,8W/m) + Inline dimmer + 12V 24W adaptor	WW (2800-3300K) W (6000-6500K) Green Blue Red Yellow
Dimmer Set B, IP65	2,5m IP65 3528 strip (9,6W/m) + Inline dimmer + 12V 24W adaptor	
Dimmer Set C, IP65	5m IP65 5050 strip (7,2W/m) + Inline dimmer + 12V 36W adaptor	
Dimmer Set D, IP65	2,5m IP65 5050 strip (14,4W/m) + Inline dimmer + 12V 36W adaptor	

BS Elektronik Service GmbH

Webseite: www.bs-elektronik-service.de E-Mail: info@bs-elektronik-service.de

Quotation of LED Set Solution (RGB)

Feature:

- 1, All below price include both product and blister package.
- 2, LED Stripe type and length can be adjusted as real needs







Item No	Description
Non Waterproof, IP 20 series	
RGB Set A, IP20	5m IP20 strip (7,2W/m) + 24-key remote + 12V 36W adaptor
RGB Set B, IP20	5m IP20 strip (7,2W/m) + 28-key remote + 12V 36W adaptor
RGB Set C, IP20	2,5m IP20 strip (14,4W/m) + 24-key remote + 12V 36W adaptor
RGB Set D, IP20	2,5m IP20 strip (14,4W/m) + 28-key remote + 12V 36W adaptor
Waterproof, IP 65 series	
RGB Set A, IP65	5m IP65 strip (7,2W/m) + 24-key remote + 12V 36W adaptor
RGB Set B, IP65	5m IP65 strip (7,2W/m) + 28-key remote + 12V 36W adaptor
RGB Set C, IP65	2,5m IP65 strip (14,4W/m) + 24-key remote + 12V 36W adaptor
RGB Set D, IP65	2,5m IP65 strip (14,4W/m) + 28-key remote + 12V 36W adaptor

BS Elektronik Service GmbH

Webseite: www.bs-elektronik-service.de E-Mail: info@bs-elektronik-service.de





Group 4: Connectors for flex led strip

Item No	Compatible PCB Board	Suitable strip	Product photo
Middle connector (strip-to-strip)			
001-8mm-2pin	2pin,8mm width PCB	SE-3528x	
001-10mm-2pin	2pin,10mm width PCB	SE-5050/5060x	
001-10mm-4pin	4pin,10mm width PCB		
15cm middle connect wire (strip-to-strip)			
002-8mm-2pin	2pin,8mm width PCB	SE-3528x	
002-10mm-2pin	2pin,10mm width PCB	SE-5050/5060x	
002-10mm-4pin	4pin,10mm width PCB		
15cm, end connect wire (driver-to-strip)			
003-8mm-2pin	2pin,8mm width PCB	SE-3528x	
003-10mm-2pin	2pin,10mm width PCB	SE-5050/5060x	
003-10mm-4pin	4pin,10mm width PCB		
20cm, end connect wire with DC connector(driver-to-strip)			
004--8mm-2pin	2pin 8mm width	SE-3528x	
004-10mm-2pin	2pin 10mm width	SE-5050/5060x	

BS Elektronik Service GmbH

Webseite: www.bs-elektronik-service.de E-Mail: info@bs-elektronik-service.de







Group 4: Connectors for flex led strip

Item No	Compatible PCB Board	Suitable strip	Product photo
Middle connector (strip-to-strip)			
101-8mm-2pin	2pin,8mm width PCB	SE-3528x	
101-10mm-2pin	2pin,10mm width PCB	SE-5050/5060x	
101-10mm-4pin	4pin,10mm width PCB		
20cm middle connect wire (strip-to-strip), male connector			
102-8mm-2pin	2pin,8mm width PCB	SE-3528x	
102-10mm-2pin	2pin,10mm width PCB	SE-5050/5060x	
102-10mm-4pin	4pin,10mm width PCB		
20cm, end connect wire (driver-to-strip), male connector			
103-8mm-2pin	2pin,8mm width PCB	SE-3528x	
103-10mm-2pin	2pin,10mm width PCB	SE-5050/5060x	
103-10mm-4pin	4pin,10mm width PCB		
20cm, end connect wire with DC connector(driver-to-strip)			
104--8mm-2pin	2pin 8mm width	SE-3528x	
104-10mm-2pin	2pin 10mm width	SE-5050/5060x	
20cm, end connect wire with DC connector(driver-to-strip)			
SE-WC-1	IP68 connector for RGB strip, wire length 15cm		
SE-WC-2	IP68 connector for single color, DC connector, wire length 15cm		

BS Elektronik Service GmbH

Webseite: www.bs-elektronik-service.de E-Mail: info@bs-elektronik-service.de





Group 4: Connectors for flex led strip

Item No	Description	MOQ	Product photo
SE-105-2L	L connector, 2pin female, white color	50	
SE-105-4L	L connector, 4pin female, white color	2	
SE-105-2T	T connector, 2pin female, white color	50	
SE-105-4T	T connector, 4pin female, white color	2	
SE-105-2C	Cross connector, 2pin female, white color	50	
SE-105-4C	Cross connector, 2pin female, white color	2	
SE-106-4T-W	T splitter with 10cm wire, 4pin female, white color wire	20	
SE-106-4C-W	Cross splitter with 10cm wire, 4pin female, white color wire	20	
SE-106-4C-W	1:3 splitter with 30cm wire, 4pin female, white color wire, parallel connection	20	

BS Elektronik Service GmbH

Webseite: www.bs-elektronik-service.de E-Mail: info@bs-elektronik-service.de

Group 4: Connectors for flex led strip

Item No	Description	Product photo
DC wire plug-female	Converts bare wires to a female DC plug.	 DC wire plug-female DC wire plug-male
DC wire plug-male	Converts bare wires to a male DC plug.	
SE-006-1m	DC plug 1m wire for long distance connection	
SE-007-4pin	4-pin femal connector with 1m wire for long distance connection	
SE-008-3	1: 3 Splitter DC connection wire	

Alle oben genannten Artikel sind in schwarz und weiß erhältlich. Andere Längen sind verfügbar. (Mindestabnahme: 200 Stk.)

Gültigkeit 2012

Lieferung: ab Werk, zzgl. Verpackung + Versicherung

Zahlung: Netto zzgl. MwSt., Mindestbestellwert 250€

Lieferzeit: ca.14-28 Tage nach Auftragseingang

Minimum Auftragsgröße: 2 Stück