

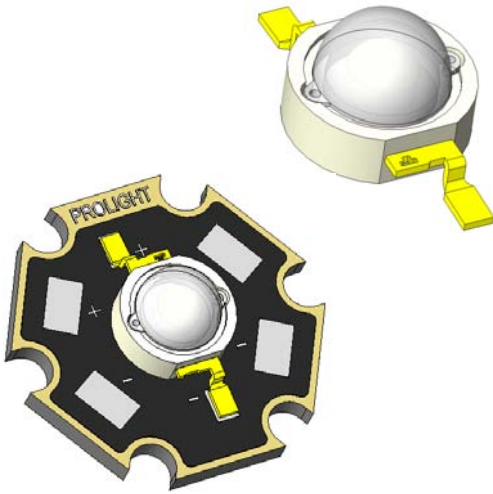

ProLight Opto
Technology Corporation



ProLight PM2A-4LXX-SD
4W White/Warm White Power LED
Technical Datasheet
Version: 1.0

Features

- High flux per LED
- Very long operating life(up to 100k hours)
- Good color uniformity
- RoHS compliant
- More energy efficient than incandescent and most halogen lamps
- Low Voltage DC operated
- Instant light (less than 100ns)
- No UV
- Superior ESD protection

Typical Applications

- Reading lights (car, bus, aircraft)
- Portable (flashlight, bicycle)
- Uplighters/Downlighters
- Decorative/Entertainment
- Bollards/Security/Garden
- Cove/Undershelf/Task
- Indoor/Outdoor Commercial and Residential Architectural
- Automotive Ext (Stop-Tail-Turn, CHMSL, Mirror Side Repeat)
- LCD backlights

ProLight

Emitter Mechanical Dimensions

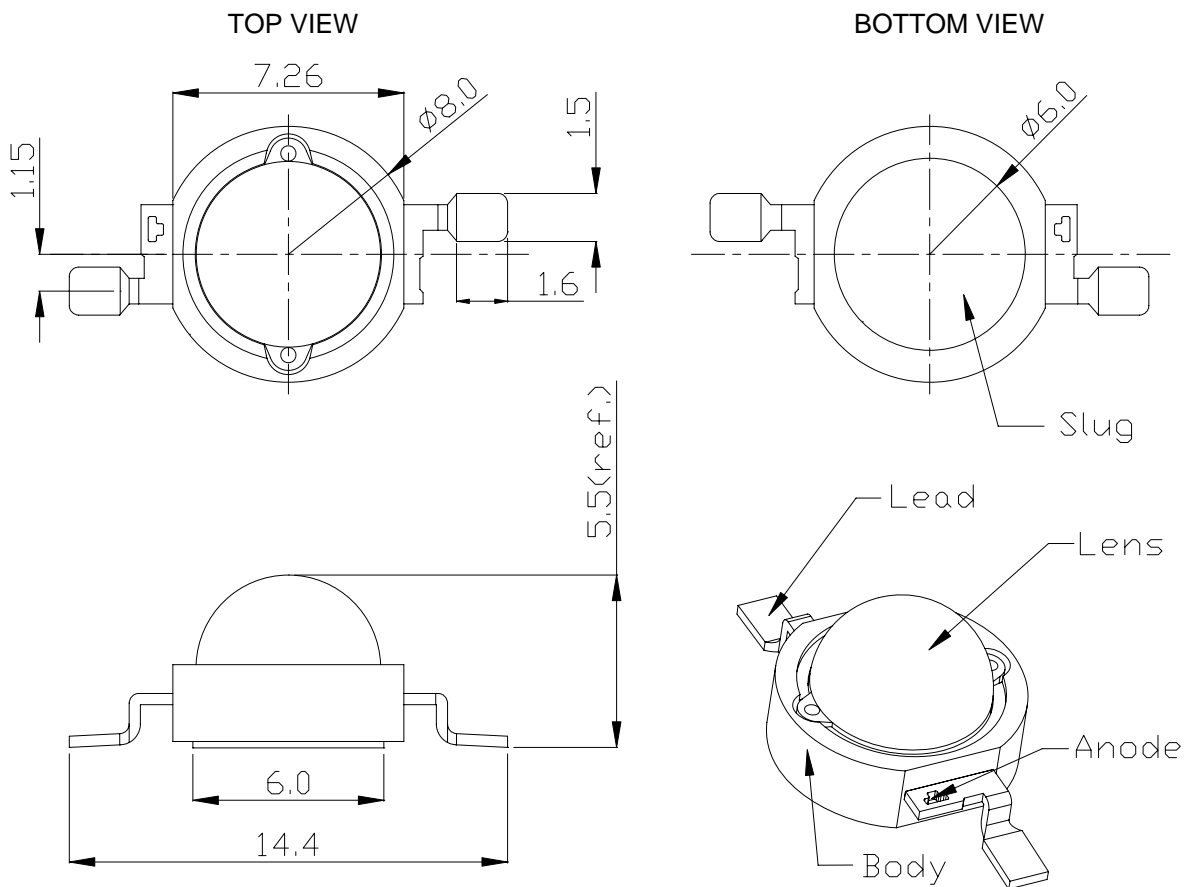

Notes:

1. The Anode side of the device is denoted by a hole in the lead frame.
2. Electrical insulation between the case and the board is required --- slug of device is not electrically neutral. Do not electrically connect either the anode or cathode to the slug.
3. Drawing not to scale.
4. All dimensions are in millimeters.
5. All dimensions without tolerances are for reference only.
6. Please do not bend the leads of the LED, otherwise it will damage the LED.

*The appearance and specifications of the product may be modified for improvement without notice.

Star Mechanical Dimensions

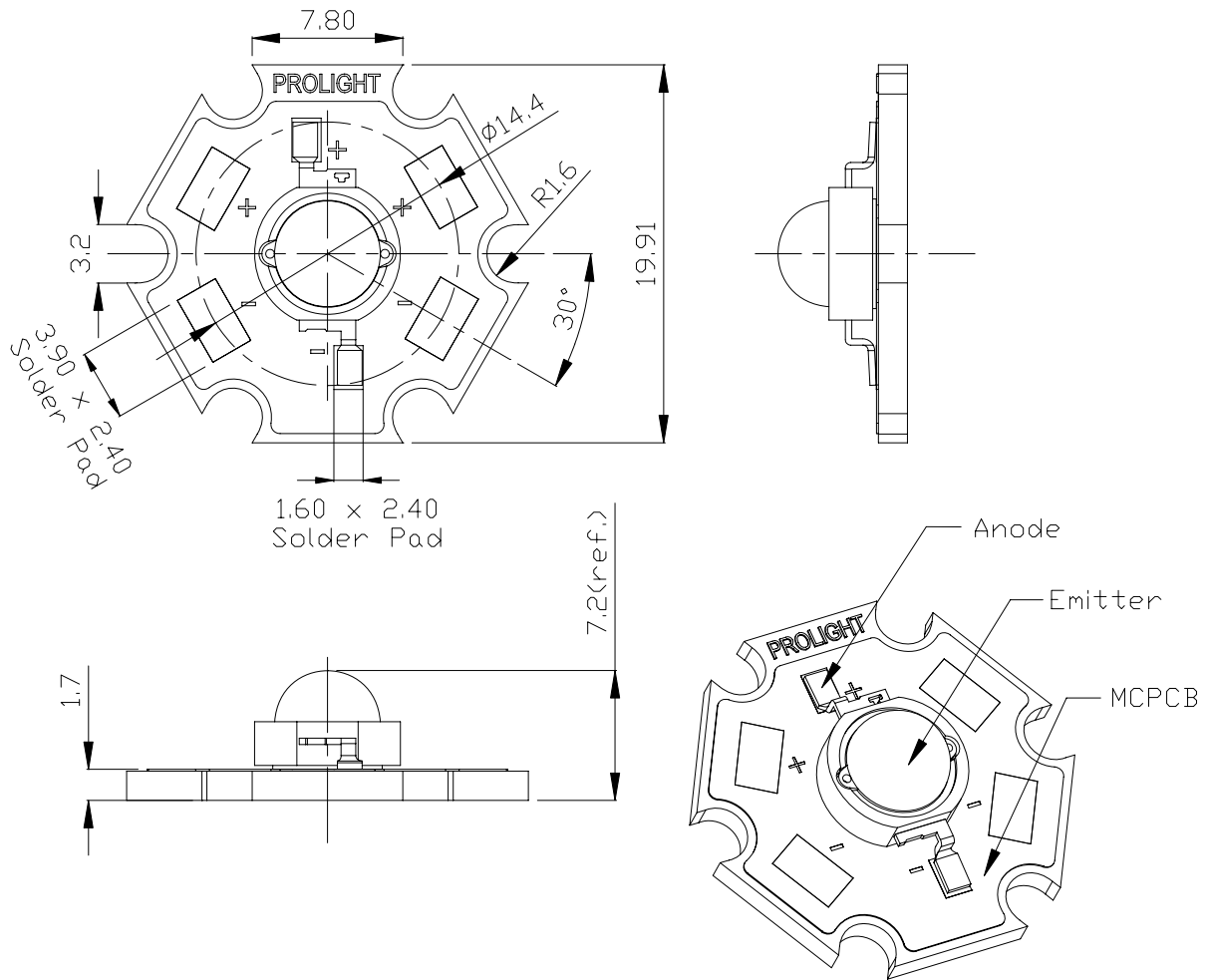

Notes:

1. Slots in aluminum-core PCB for M3 or #4 mounting screw.
2. Electrical interconnection pads labeled on the aluminum-core PCB with "+" and "-" to denote positive and negative, respectively. All positive pads are interconnected, as are all negative pads, allowing for flexibility in array interconnection.
3. Drawing not to scale.
4. All dimensions are in millimeters.
5. All dimensions without tolerances are for reference only.

*The appearance and specifications of the product may be modified for improvement without notice.

Part Number

Radiation Pattern	Color	Emitter	Star
Lambertian	White	PM2A-4LWE-SD	PM2A-4LWS-SD
	Warm White	PM2A-4LVE-SD	PM2A-4LVS-SD

Flux Characteristics, $T_J = 25^\circ\text{C}$

Radiation Pattern	Color	Typical Luminous Flux Φ_V (lm)		
		Test @1000mA	Refer @700mA	Refer @350mA
Lambertian	White	200	150	85
	Warm White	180	135	77

- ProLight maintains a tolerance of $\pm 10\%$ on flux and power measurements.
- Please do not drive at rated current more than 1 second without proper heat sink.

Electrical Characteristics at 1000mA, $T_J = 25^\circ\text{C}$

Color	Forward Voltage V_F (V)			Dynamic Resistance (Ω)	Temperature Coefficient of V_F (mV/°C) $\Delta V_F / \Delta T_J$	Thermal Resistance Junction to Slug ($^\circ\text{C}/\text{W}$)
	Min.	Typ.	Max.			
White	3.3	3.8	4.5	1.0	-2.0	12
Warm White	3.3	3.8	4.5	1.0	-2.0	12

Optical Characteristics at 1000mA, $T_J = 25^\circ\text{C}$

Radiation Pattern	Color	Dominant Wavelength λ_D , or Color Temperature CCT			Spectral Half-width (nm) $\Delta\lambda_{1/2}$	Temperature Coefficient of Dominant Wavelength (nm/°C) $\Delta\lambda_D / \Delta T_J$	Total included Angle (degrees) $\theta_{0.90V}$	Viewing Angle (degrees) $2\theta_{1/2}$
		Min.	Typ.	Max.				
Lambertian	White	4100 K	5500 K	10000 K	---	---	180	130
	Warm White	2700 K	3300 K	4100 K	---	---	180	130

- ProLight maintains a tolerance of $\pm 5\%$ for CCT measurements.

Absolute Maximum Ratings

Parameter	White/Warm White
DC Forward Current (mA)	1000
Peak Pulsed Forward Current (mA)	1250
Average Forward Current (mA)	1000
ESD Sensitivity	±16000V HBM
LED Junction Temperature (°C)	150
Aluminum-core PCB Temperature (°C)	105
Storage & Operating Temperature (°C)	-40 to +105
Soldering Temperature(°C)	230 for 10 seconds Max.

Photometric Luminous Flux Bin Structure

Color	Bin Code	Minimum Photometric Flux (lm)	Maximum Photometric Flux (lm)
White	W1	147.7	168.4
	W2	168.4	192.0
	X1	192.0	218.9
Warm White	W1	147.7	168.4
	W2	168.4	192.0
	X1	192.0	218.9

- ProLight maintains a tolerance of $\pm 10\%$ on flux and power measurements.

Color Bin

White and Warm White Binning Structure Graphical Representation

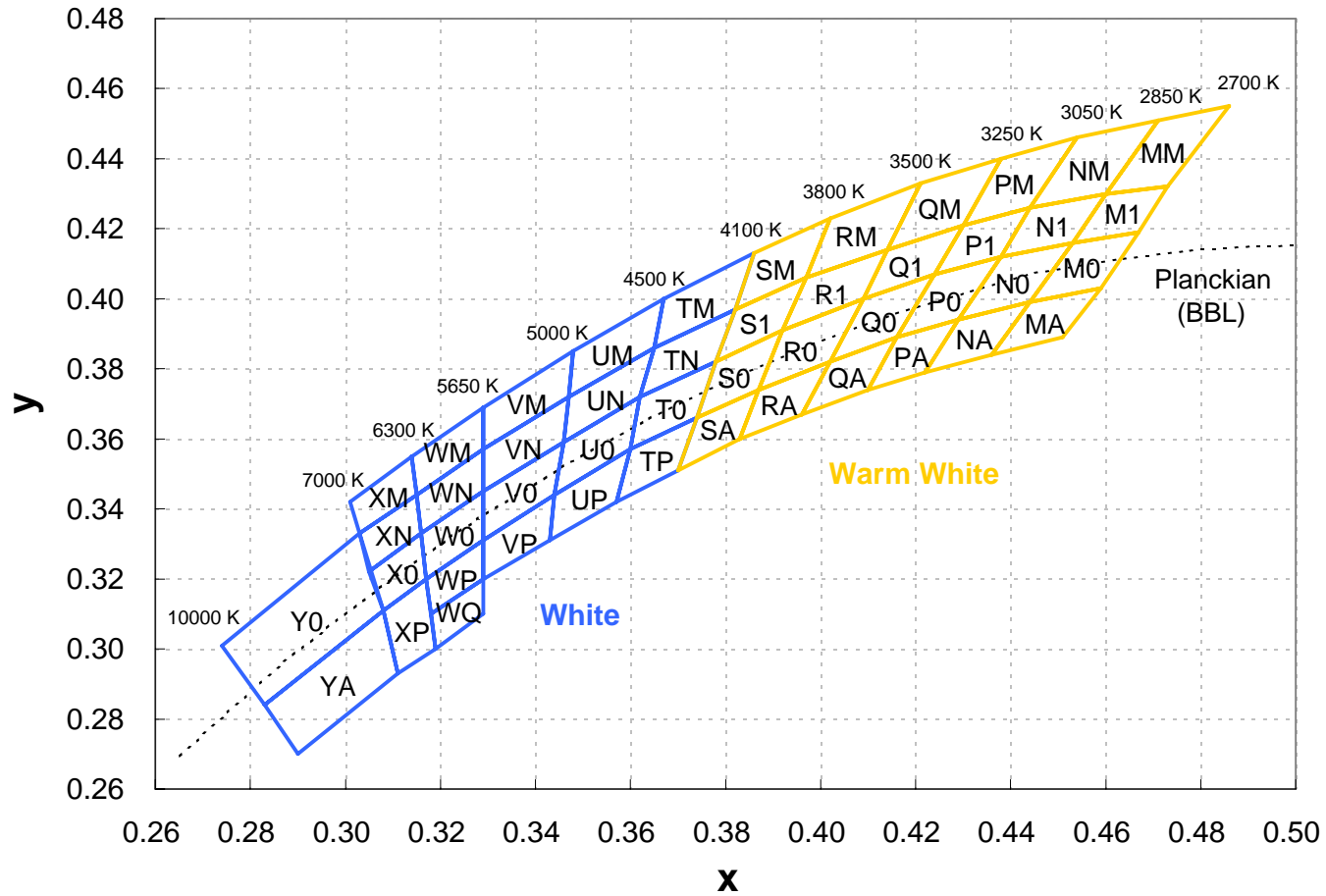

ProLight

Color Bins

White Bin Structure

Bin Code	x	y	Typ. CCT (K)	Bin Code	x	y	Typ. CCT (K)
T0	0.378	0.382	4300	W0	0.329	0.345	5970
	0.374	0.366			0.329	0.331	
	0.360	0.357			0.317	0.320	
	0.362	0.372			0.316	0.333	
TN	0.382	0.397	4300	WN	0.329	0.345	5970
	0.378	0.382			0.316	0.333	
	0.362	0.372			0.315	0.344	
	0.365	0.386			0.329	0.357	
TP	0.374	0.366	4300	WP	0.329	0.331	5970
	0.370	0.351			0.329	0.320	
	0.357	0.342			0.318	0.310	
	0.360	0.357			0.317	0.320	
TM	0.386	0.413	4300	WQ	0.329	0.320	5970
	0.382	0.397			0.329	0.310	
	0.365	0.386			0.319	0.300	
	0.367	0.400			0.318	0.310	
U0	0.362	0.372	4750	WM	0.329	0.369	5970
	0.360	0.357			0.329	0.357	
	0.344	0.344			0.315	0.344	
	0.346	0.359			0.314	0.355	
UN	0.365	0.386	4750	X0	0.308	0.311	6650
	0.362	0.372			0.305	0.322	
	0.346	0.359			0.316	0.333	
	0.347	0.372			0.317	0.320	
UP	0.360	0.357	4750	XN	0.305	0.322	6650
	0.357	0.342			0.303	0.333	
	0.343	0.331			0.315	0.344	
	0.344	0.344			0.316	0.333	
UM	0.365	0.386	4750	XP	0.308	0.311	6650
	0.367	0.400			0.317	0.320	
	0.348	0.385			0.319	0.300	
	0.347	0.372			0.311	0.293	
V0	0.329	0.331	5320	XM	0.301	0.342	6650
	0.329	0.345			0.314	0.355	
	0.346	0.359			0.315	0.344	
	0.344	0.344			0.303	0.333	
VN	0.329	0.345	5320	Y0	0.308	0.311	8000
	0.329	0.357			0.283	0.284	
	0.347	0.372			0.274	0.301	
	0.346	0.359			0.303	0.333	
VP	0.329	0.331	5320	YA	0.308	0.311	8000
	0.344	0.344			0.311	0.293	
	0.343	0.331			0.290	0.270	
	0.329	0.320			0.283	0.284	
VM	0.329	0.357	5320				
	0.329	0.369					
	0.348	0.385					
	0.347	0.372					

- Tolerance on each color bin (x , y) is ± 0.01

Note: Although several bins are outlined, product availability in a particular bin varies by production run and by product performance. Not all bins are available in all colors.

Color Bins

Warm White Bin Structure

Bin Code	x	y	Typ. CCT (K)	Bin Code	x	y	Typ. CCT (K)
M0	0.453	0.416	2770	Q0	0.409	0.400	3370
	0.444	0.399			0.402	0.382	
	0.459	0.403			0.416	0.389	
	0.467	0.419			0.424	0.407	
M1	0.460	0.430	2770	Q1	0.414	0.414	3370
	0.453	0.416			0.409	0.400	
	0.467	0.419			0.424	0.407	
	0.473	0.432			0.430	0.421	
MA	0.459	0.403	2770	QA	0.416	0.389	3370
	0.444	0.399			0.402	0.382	
	0.436	0.384			0.396	0.367	
	0.451	0.389			0.410	0.374	
MM	0.471	0.451	2770	QM	0.421	0.433	3370
	0.460	0.430			0.414	0.414	
	0.473	0.432			0.430	0.421	
	0.486	0.455			0.438	0.440	
N0	0.438	0.412	2950	R0	0.392	0.391	3650
	0.429	0.394			0.387	0.374	
	0.444	0.399			0.402	0.382	
	0.453	0.416			0.409	0.400	
N1	0.444	0.426	2950	R1	0.414	0.414	3650
	0.438	0.412			0.409	0.400	
	0.453	0.416			0.392	0.391	
	0.460	0.430			0.397	0.406	
NA	0.444	0.399	2950	RA	0.387	0.374	3650
	0.429	0.394			0.383	0.360	
	0.422	0.379			0.396	0.367	
	0.436	0.384			0.402	0.382	
NM	0.454	0.446	2950	RM	0.421	0.433	3650
	0.444	0.426			0.414	0.414	
	0.460	0.430			0.397	0.406	
	0.471	0.451			0.402	0.423	
P0	0.424	0.407	3150	S0	0.392	0.391	3950
	0.416	0.389			0.387	0.374	
	0.429	0.394			0.374	0.366	
	0.438	0.412			0.378	0.382	
P1	0.430	0.421	3150	S1	0.397	0.406	3950
	0.424	0.407			0.392	0.391	
	0.438	0.412			0.378	0.382	
	0.444	0.426			0.382	0.397	
PA	0.429	0.394	3150	SA	0.387	0.374	3950
	0.416	0.389			0.383	0.360	
	0.410	0.374			0.370	0.351	
	0.422	0.379			0.374	0.366	
PM	0.438	0.440	3150	SM	0.402	0.423	3950
	0.430	0.421			0.397	0.406	
	0.444	0.426			0.382	0.397	
	0.454	0.446			0.386	0.413	

- Tolerance on each color bin (x , y) is ± 0.01

Note: Although several bins are outlined, product availability in a particular bin varies by production run and by product performance. Not all bins are available in all colors.

Color Spectrum, $T_J = 25^\circ\text{C}$

1. White

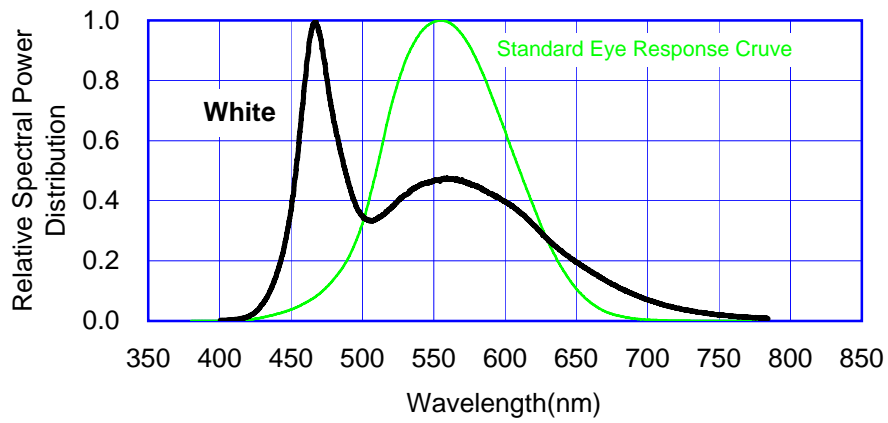

2. Warm White

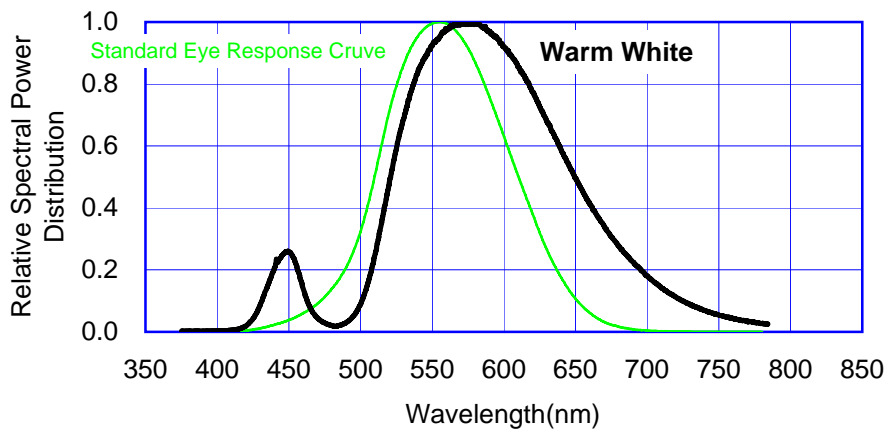

Light Output Characteristics

Relative Light Output vs. Junction Temperature at 1000mA

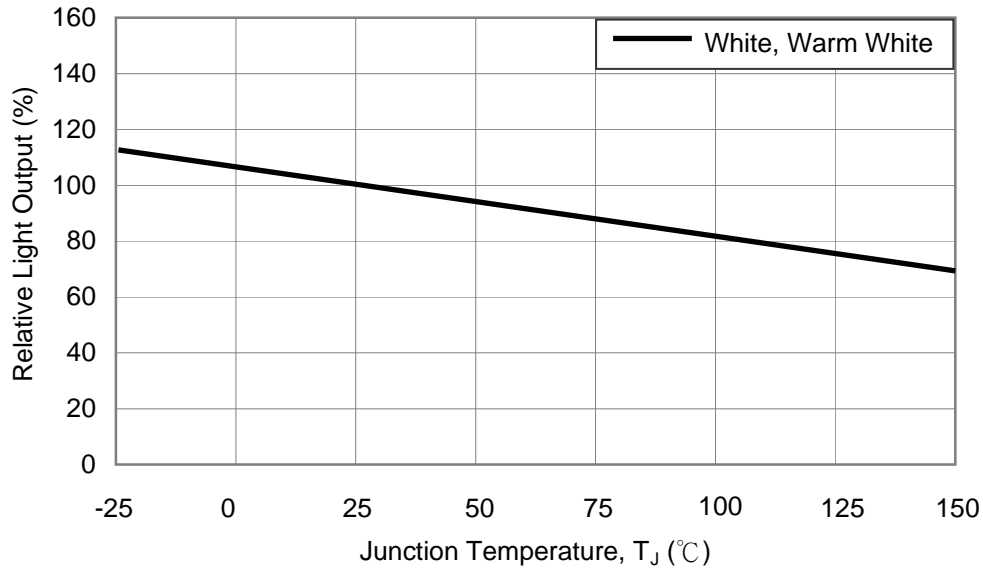

Forward Current Characteristics, $T_j=25^\circ\text{C}$

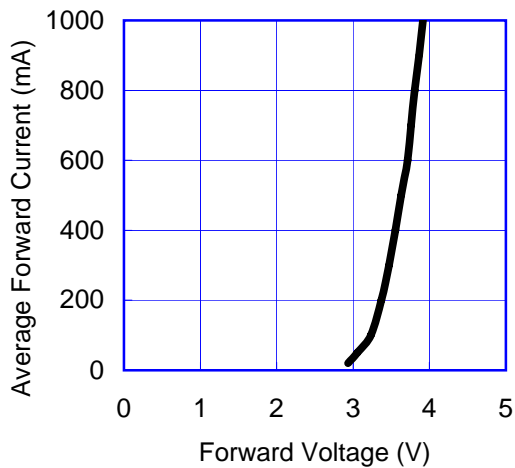

Fig 1. Forward Current vs. Forward Voltage for White and Warm White.

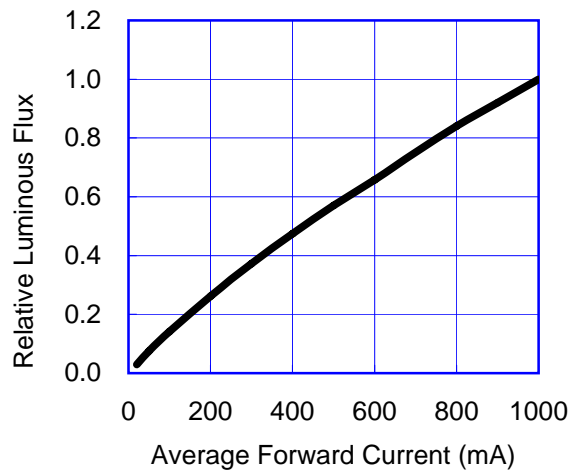
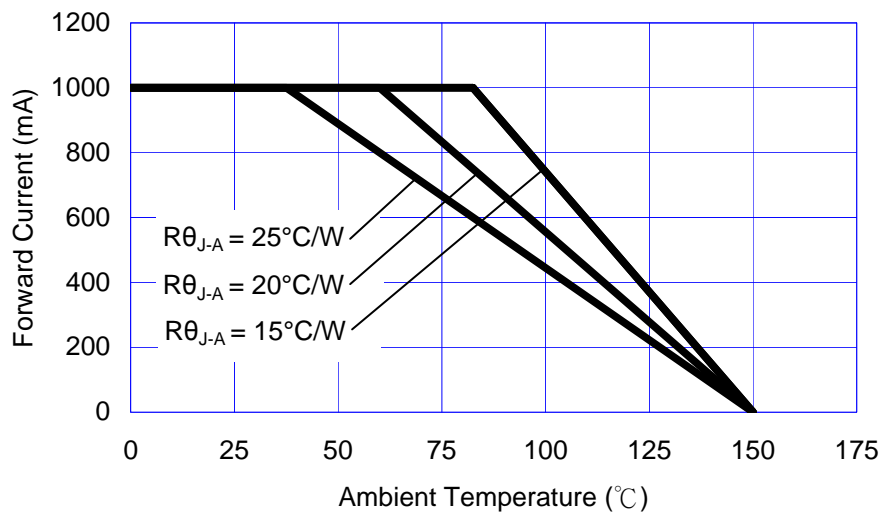

Fig 2. Relative Luminous Flux vs. Forward Current for White and Warm White at $T_j=25^\circ\text{C}$ maintained.

Ambient Temperature vs. Maximum Forward Current

White, Warm White ($T_{JMAX} = 150^{\circ}\text{C}$)



Typical Representative Spatial Radiation Pattern

Lambertian Radiation Pattern

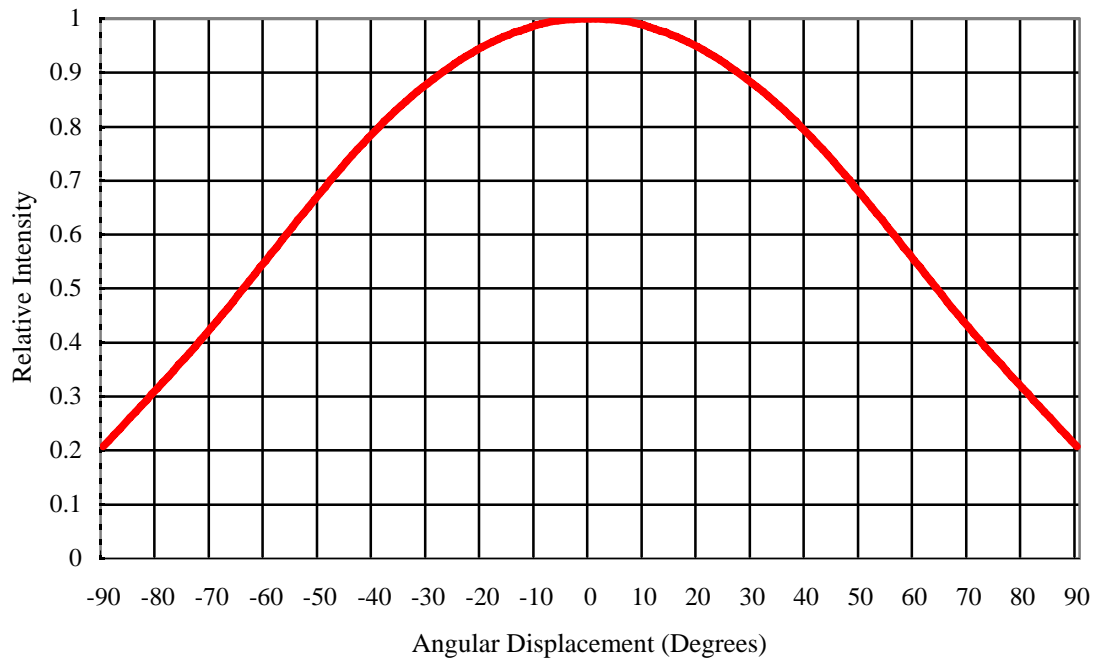

Qualification Reliability Testing

Stress Test	Stress Conditions	Stress Duration	Failure Criteria
Room Temperature Operating Life (RTOL)	25°C, $I_F = \text{max DC}$ (Note 1)	1000 hours	Note 2
Wet High Temperature Operating Life (WHTOL)	85°C/60%RH, $I_F = \text{max DC}$ (Note 1)	1000 hours	Note 2
Wet High Temperature Storage Life (WHTSL)	85°C/85%RH, non-operating	1000 hours	Note 2
High Temperature Storage Life (HTSL)	110°C, non-operating	1000 hours	Note 2
Low Temperature Storage Life (LTSL)	-40°C, non-operating	1000 hours	Note 2
Non-operating Temperature Cycle (TMCL)	-40°C to 120°C, 30 min. dwell, <5 min. transfer	200 cycles	Note 2
Non-operating Thermal Shock (TMSK)	-40°C to 120°C, 20 min. dwell, <20 sec. transfer	200 cycles	Note 2
Mechanical Shock	1500 G, 0.5 msec. pulse, 5 shocks each 6 axis		Note 3
Natural Drop	On concrete from 1.2 m, 3X		Note 3
Variable Vibration Frequency	10-2000-10 Hz, log or linear sweep rate, 20 G about 1 min., 1.5 mm, 3X/axis		Note 3
Solder Heat Resistance (SHR)	260°C ± 5°C, 10 sec.		Note 3
Solderability	Steam age for 16 hrs., then solder dip at 260°C for 5 sec.		Solder coverage on lead

Notes:

1. Depending on the maximum derating curve.
2. Criteria for judging failure

Item	Test Condition	Criteria for Judgement	
		Min.	Max.
Forward Voltage (V_F)	$I_F = \text{max DC}$	-	Initial Level x 1.1
Luminous Flux or Radiometric Power (Φ_V)	$I_F = \text{max DC}$	Initial Level x 0.7	-
Reverse Current (I_R)	$V_R = 5V$	-	50 μA

* The test is performed after the LED is cooled down to the room temperature.

3. A failure is an LED that is open or shorted.

Recommended Solder Pad Design

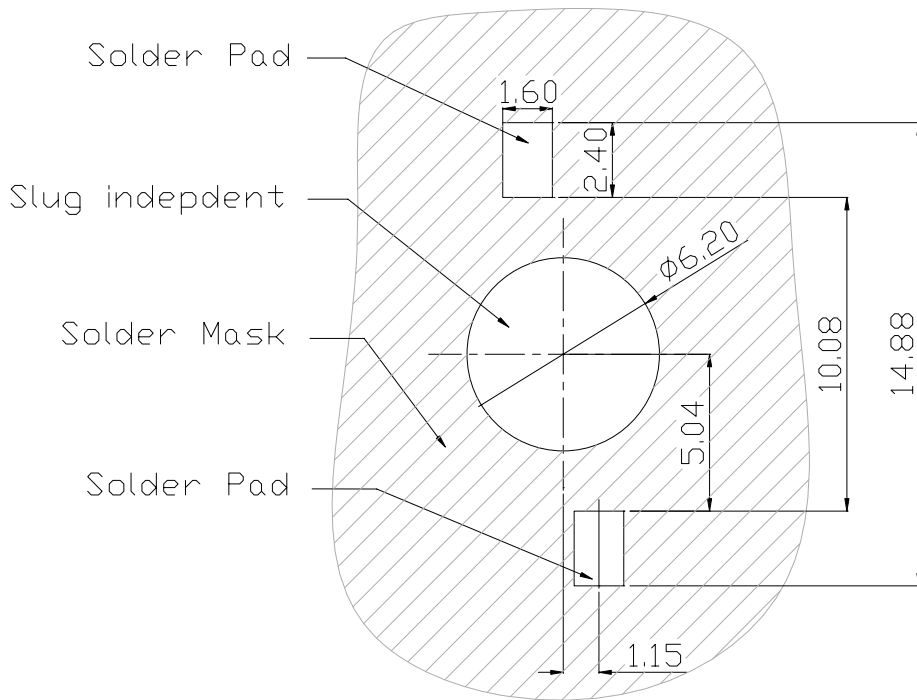

- All dimensions are in millimeters.
- Electrical isolation is required between Slug and Solder Pad.

Heat Plate Soldering Condition

(1) Soldering Process for Solder Paste

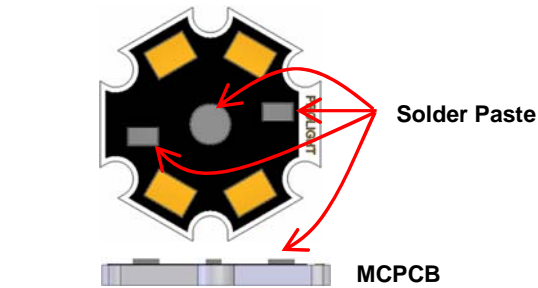

Use Solder Mask to print Solder Paste on MCPCB.

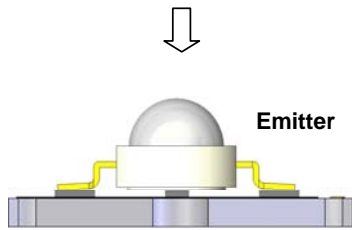

Place Emitter on MCPCB.

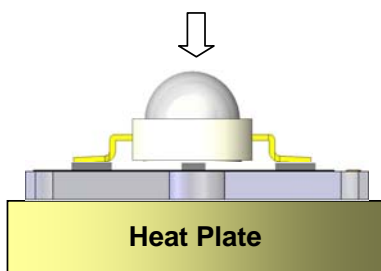

Put MCPCB on Heat Plate until Solder Paste melt.
The Solder Paste could be melted within 8 seconds.
Take out MCPCB out from Heat Plate within 10 seconds.

(2) Soldering Process for Solder Wire



Put MCPCB on Heat Plate.

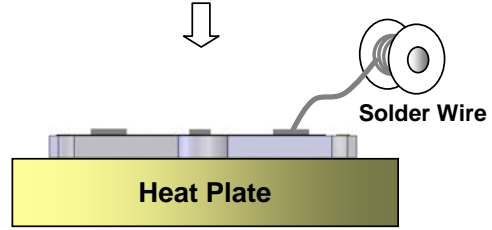

Place Solder Wire to the solder pad of MCPCB.

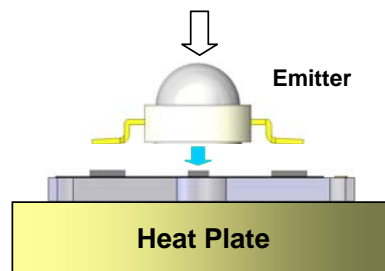

Put Emitter on MCPCB. Take the MCPCB out from Heat Plate within 10 seconds.

- Heat plate temperature: 230°C max for Lead Solder and 230°C max for Lead-Free Solder.
- When soldering, do not put stress on the LEDs during heating.
- After soldering, do not warp the circuit board.

Manual Hand Soldering

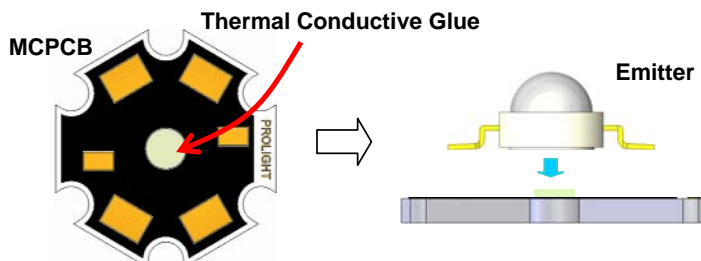

Place Thermal Comductive Glue on the MCPCB.

Place Emitter on the MCPCB.

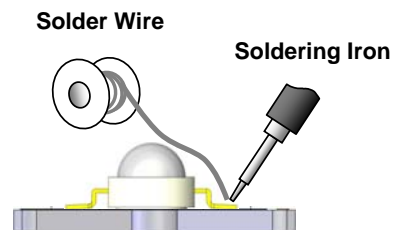

Use Soldering Iron to solder the leads of Emitter within 5 seconds.

- For prototype builds or small series production runs it possible to place and solder the emitters by hand.
- Solder tip temperature: 230°C max for Lead Solder and 260°C max for Lead-Free Solder.
- Avoiding damage to the emitter or to the MCPCB dielectric layer. Damage to the epoxy layer can cause a short circuit in the array.
- Do not let the solder contact from solder pad to back-side of MCPCB. This one will cause a short circuit and damage emitter.

Emitter Tube Packaging

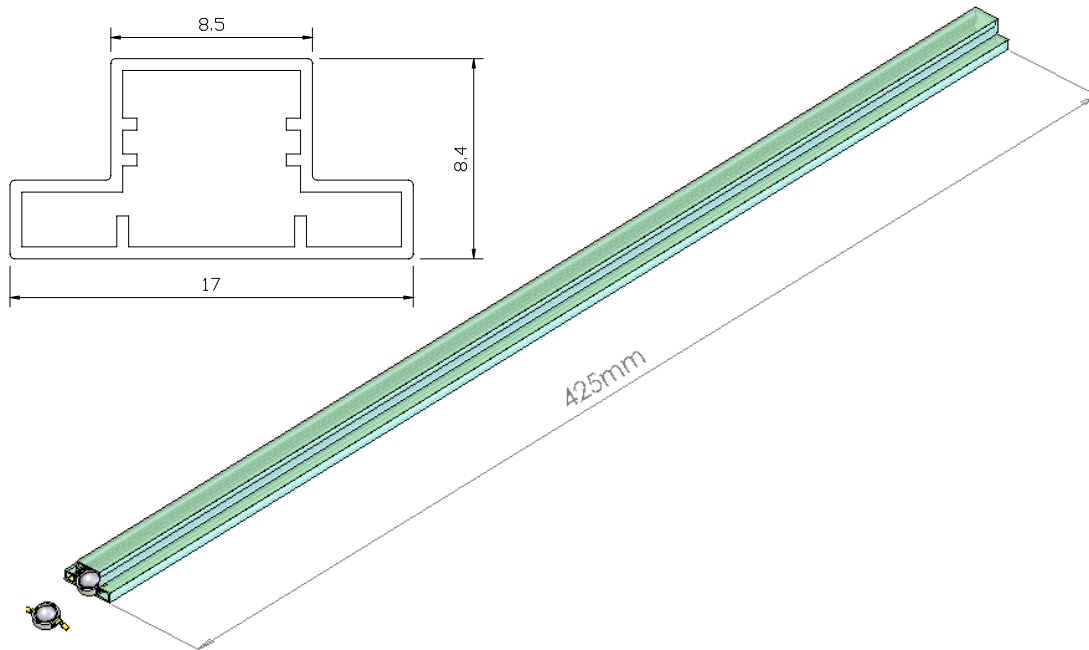

Star Tube Packaging

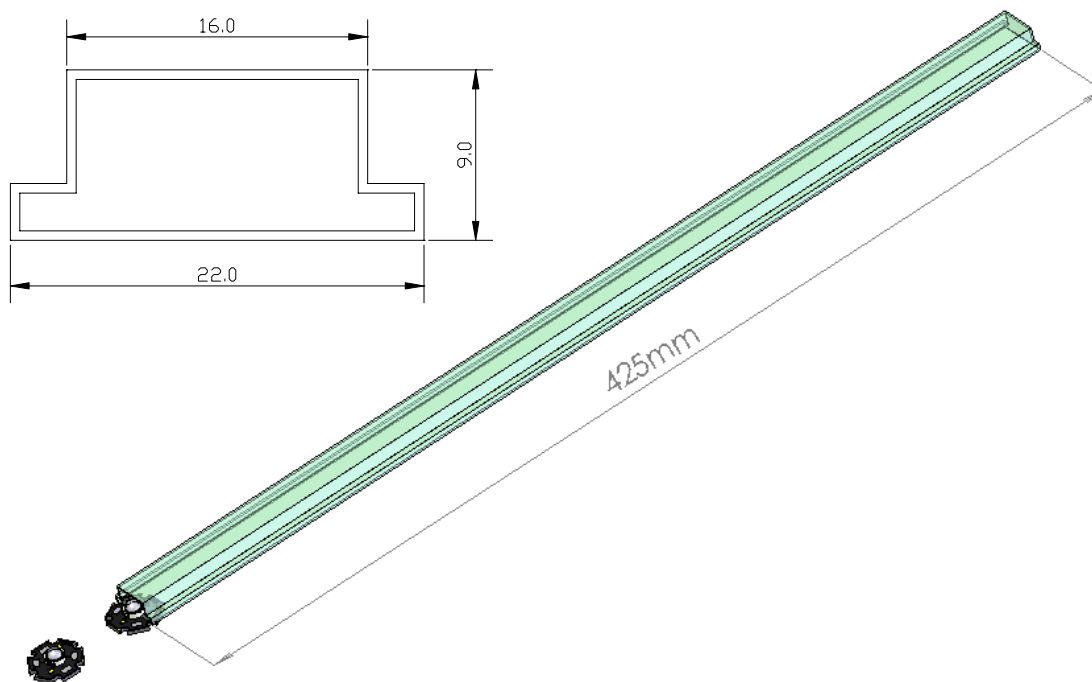

Notes:

1. Emitter 50 pieces per tube and Star 20 pieces per tube.
2. Drawing not to scale.
3. All dimensions are in millimeters.
4. All dimensions without tolerances are for reference only.

**Please do not open the moisture barrier bag (MBB) more than one week. This may cause the leads of LED discoloration. We recommend storing ProLight's LEDs in a dry box after opening the MBB. The recommended storage conditions are temperature 5 to 30°C and humidity less than 40% RH.

Precaution for Use

- Storage

Please do not open the moisture barrier bag (MBB) more than one week. This may cause the leads of LED discoloration. We recommend storing ProLight's LEDs in a dry box after opening the MBB. The recommended storage conditions are temperature 5 to 30°C and humidity less than 40% RH. It is also recommended to return the LEDs to the MBB and to reseal the MBB.

- The slug is not electrically neutral. Therefore, we recommend to isolate the heat sink.
- The slug is to be soldered. If not, please use the heat conductive adhesive.
- Any mechanical force or any excess vibration shall not be accepted to apply during cooling process to normal temperature after soldering.
- Please avoid rapid cooling after soldering.
- Components should not be mounted on warped direction of PCB.
- Repairing should not be done after the LEDs have been soldered. When repairing is unavoidable, a heat plate should be used. It should be confirmed beforehand whether the characteristics of the LEDs will or will not be damaged by repairing.
- This device should not be used in any type of fluid such as water, oil, organic solvent and etc. When cleaning is required, isopropyl alcohol should be used.
- When the LEDs are illuminating, operating current should be decided after considering the package maximum temperature.
- The appearance and specifications of the product may be modified for improvement without notice.